

# 21

# JBEAD FRAME

# AAG100 SHOWN

JBEAD for wall and ceiling applications with fixed core.

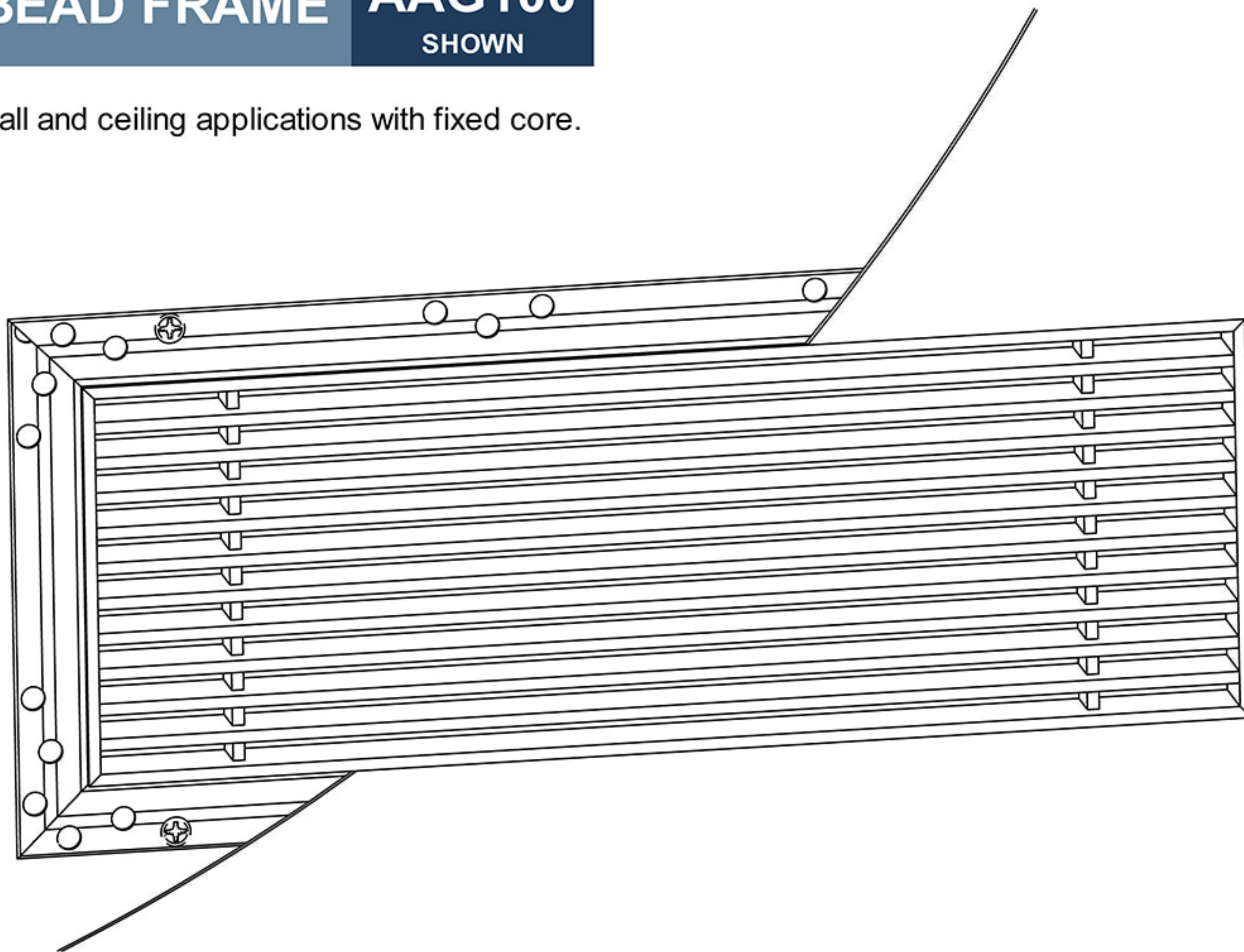

**Artistry in Architectural Grilles**  
custom architectural grilles and metal-work

SECTION NAME: JBEAD-FRAME SECTION	
TITLE: INSTALLATION DETAIL	
DRAWN BY: QW	DRAWING # # 21
DATE:	SCALE: NOT TO SCALE

**ADVANCED ARCH GRILLES**  
149 Denton Avenue, New Hyde Park, NY 11040  
Voice: 516-488-0628 Fax: 516-488-0728  
Email: sales@aagrilles.com