

# 14

## B FRAME

*Inverted with mounting holes*

## AAG110

SHOWN

Inverted B frame with countersunk mounting holes in the flange – used in millwork, as a thru-door grille or under mount for a counter.

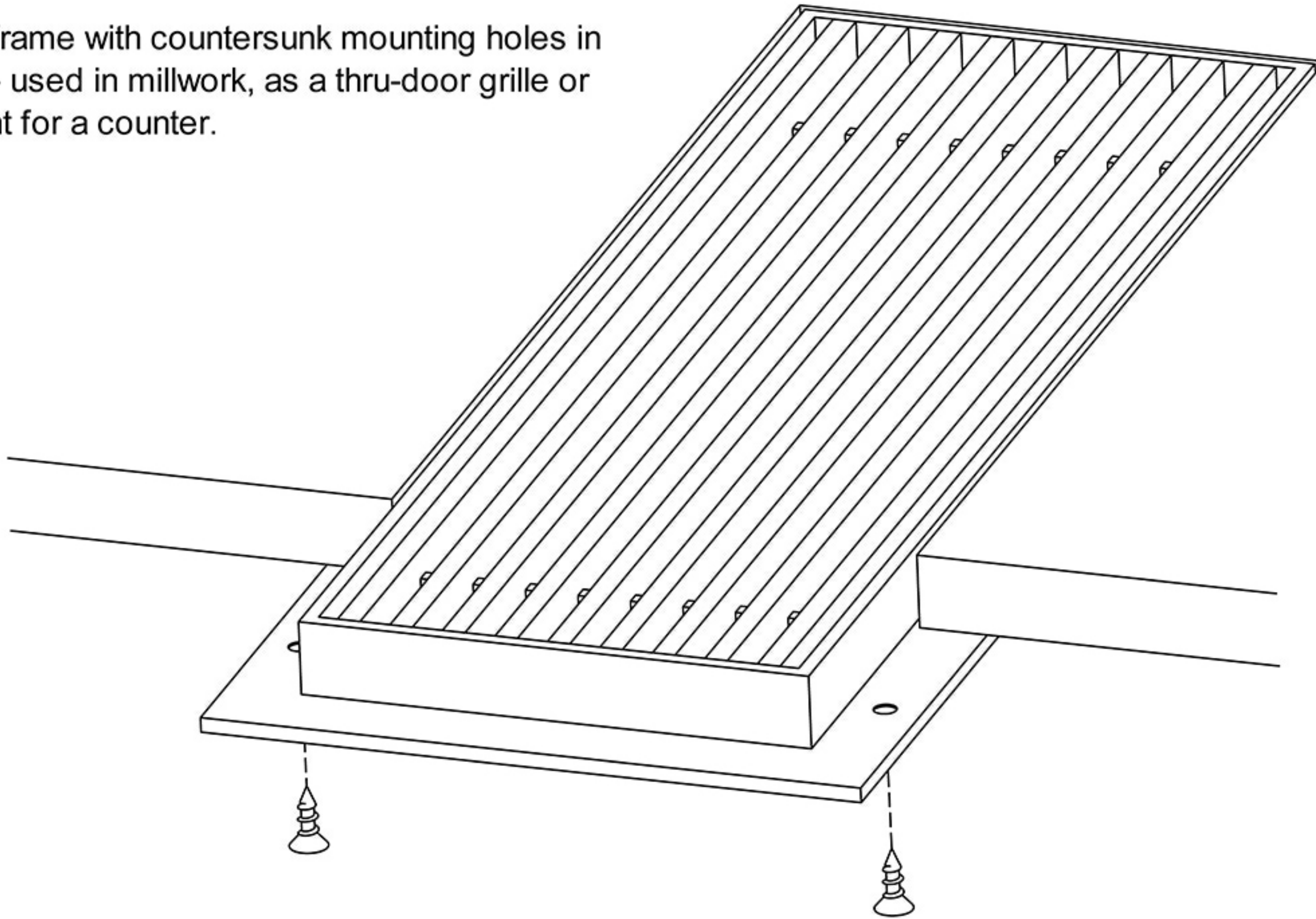

**Artistry in Architectural Grilles**  
custom architectural grilles and metal-work

SECTION NAME: B-FRAME SECTION	
TITLE: INSTALLATION DETAIL	
DRAWN BY: QW	DRAWING # # 14
DATE:	SCALE: NOT TO SCALE

**ADVANCED ARCH GRILLES**  
149 Denton Avenue, New Hyde Park, NY 11040  
Voice: 516-488-0628 Fax: 516-488-0728  
Email: sales@agrilles.com