

14

B FRAME

Inverted with mounting holes

AAG220

SHOWN

Inverted B frame with countersunk mounting holes in the flange – used in millwork, as a thru-door grille or under mount for a counter.

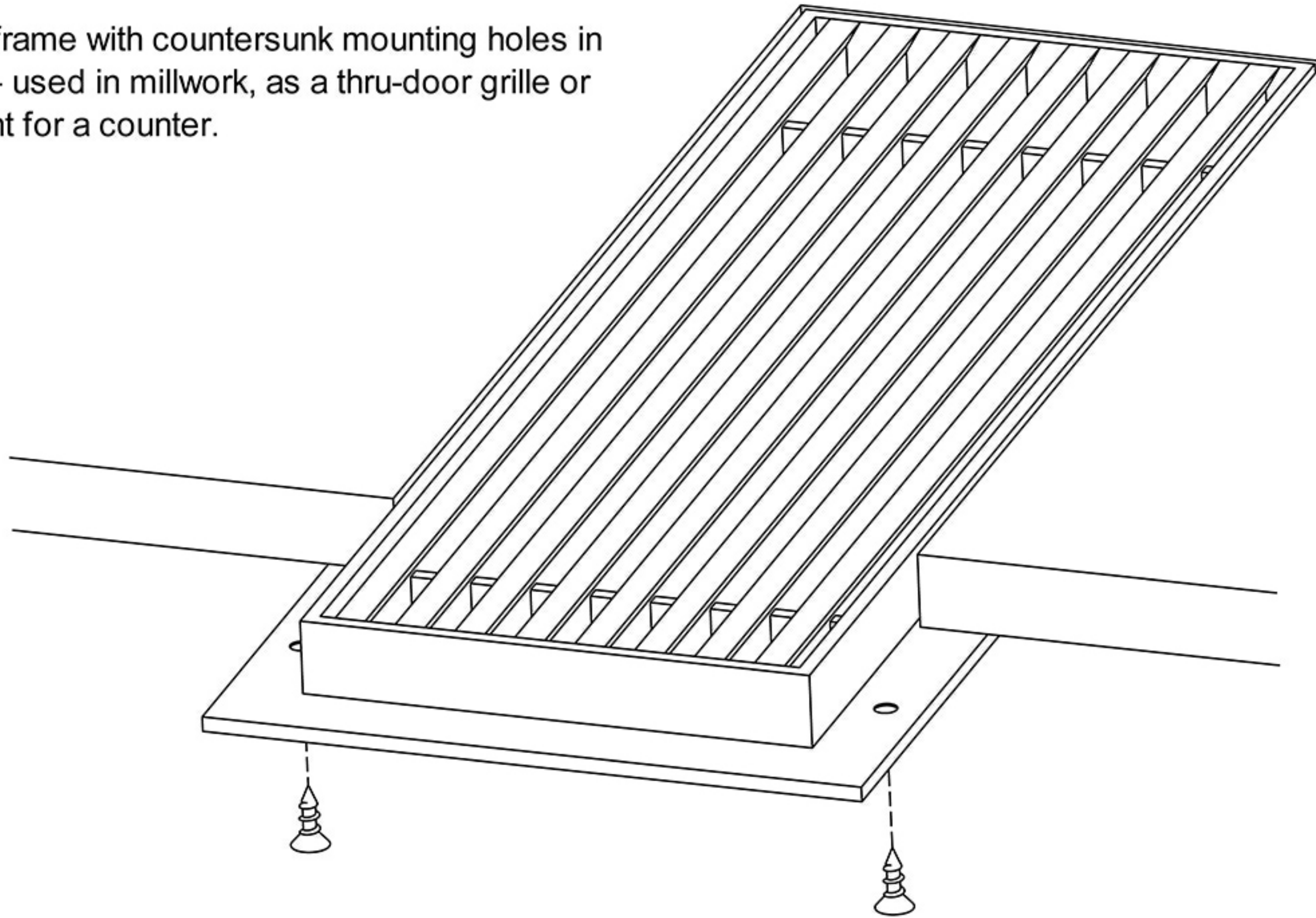

Artistry in Architectural Grilles
custom architectural grilles and metal-work

SECTION NAME: B-FRAME SECTION	
TITLE: INSTALLATION DETAIL	
DRAWN BY: QW	DRAWING # # 14
DATE:	SCALE: NOT TO SCALE

ADVANCED ARCH GRILLES
149 Denton Avenue, New Hyde Park, NY 11040
Voice: 516-488-0628 Fax: 516-488-0728
Email: sales@agrilles.com