



# ADVANCED ARCHITECTURAL GRILLEWORKS

*Creating Artistry in Architectural Grilles & Metal*

Installation Detail # 21

PLASTER J-BEAD FRAME®

Patent #9,765,988

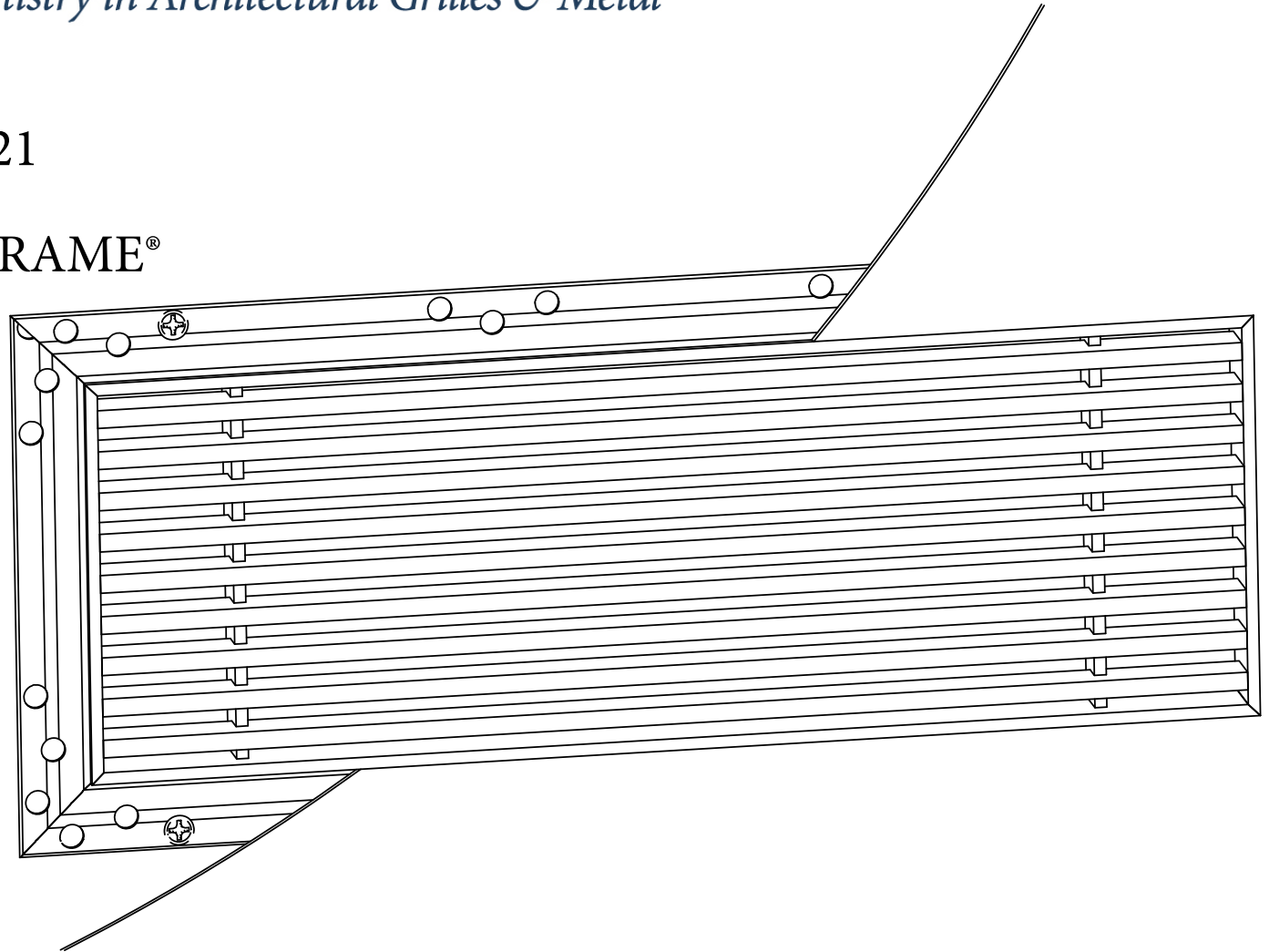

*Used for multiple applications:*

- Ceiling
- Wall

*AAG provides mounting fasteners with matching finish.*

SECTION NAME: AAG110 J-Bead Frame

TITLE: Installation Detail # 21

DRAWN BY: AAG

DRAWING #: 21-1

DATE: 11-30-18

SCALE: Not To Scale

**Advanced Architectural Grilleworks**

149 Denton Avenue, New Hyde Park, NY 11040

Voice: 516-488-0628

Email: sales@agrilles.com