



# ADVANCED ARCHITECTURAL GRILLEWORKS

*Creating Artistry in Architectural Grilles & Metal*

## Installation Detail # 12

### WITH MOUNTING TABS

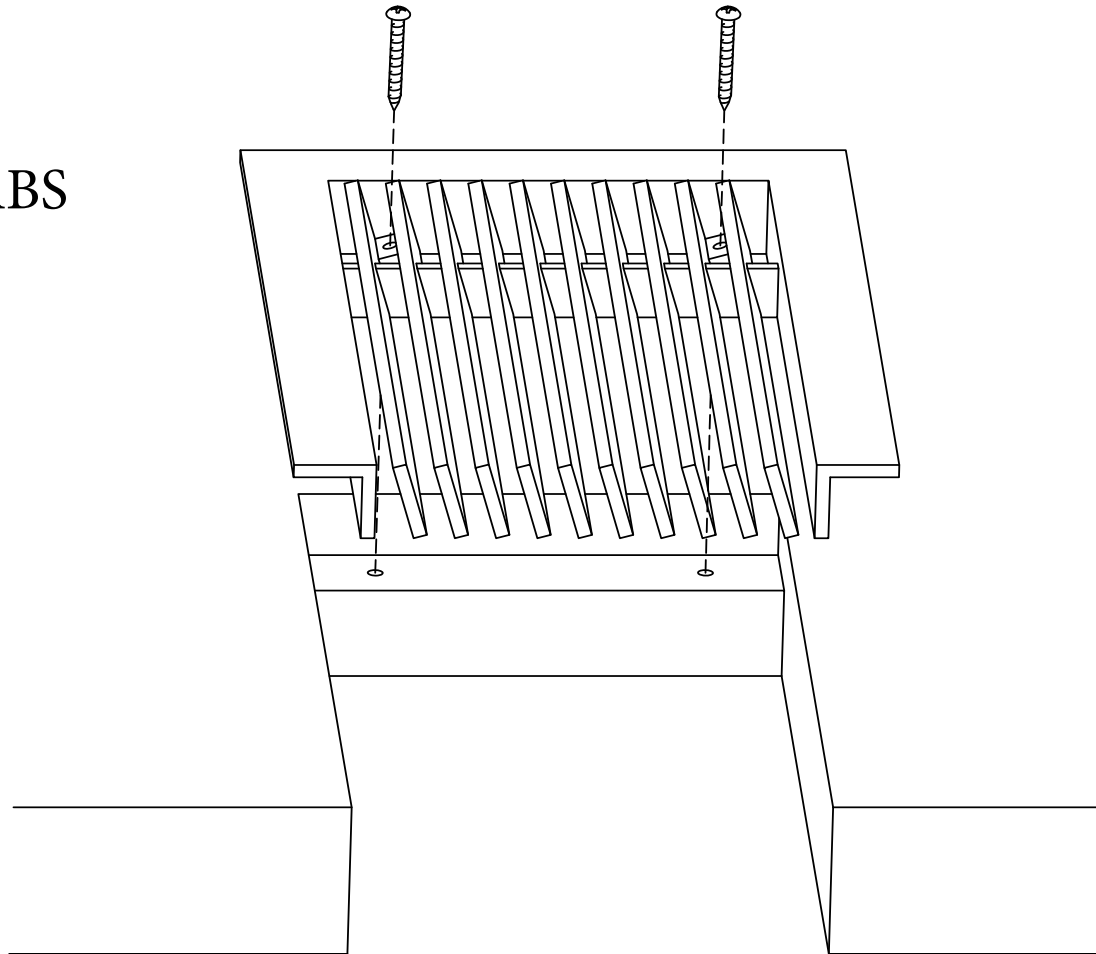

AAG Tip: We will fabricate the neck  
1/8" smaller than your opening.

#### *Used for multiple applications:*

- Blocking
- Millwork
- Supports
- Angle/Duct flange

*AAG provides mounting fasteners with matching finish*

SECTION NAME: AAG400 B Frame

TITLE: Installation Detail # 12

DRAWN BY: AAG

DRAWING #: 12-1

DATE: 11-30-18

SCALE: Not To Scale

#### **Advanced Architectural Grilleworks**

149 Denton Avenue, New Hyde Park, NY 11040

Voice: 516-488-0628

Email: [sales@agrilles.com](mailto:sales@agrilles.com)