

JOB NUMBER:

B-Frame

BAR STYLE: 110



ADVANCED ARCHITECTURAL GRILLEWORKS

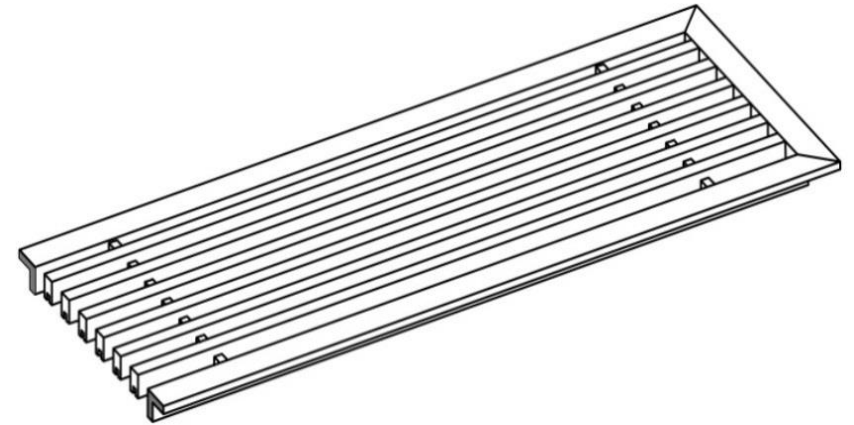
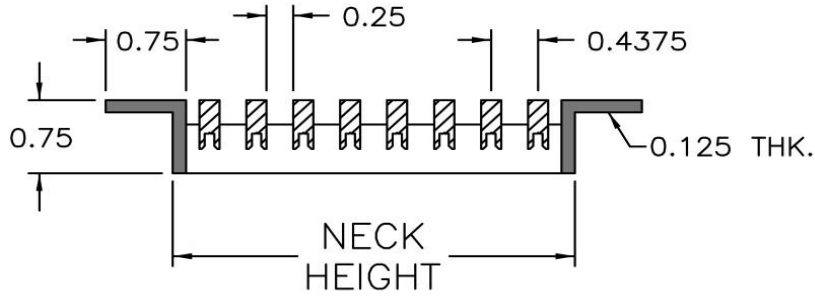

NOTE: WELDED CORE

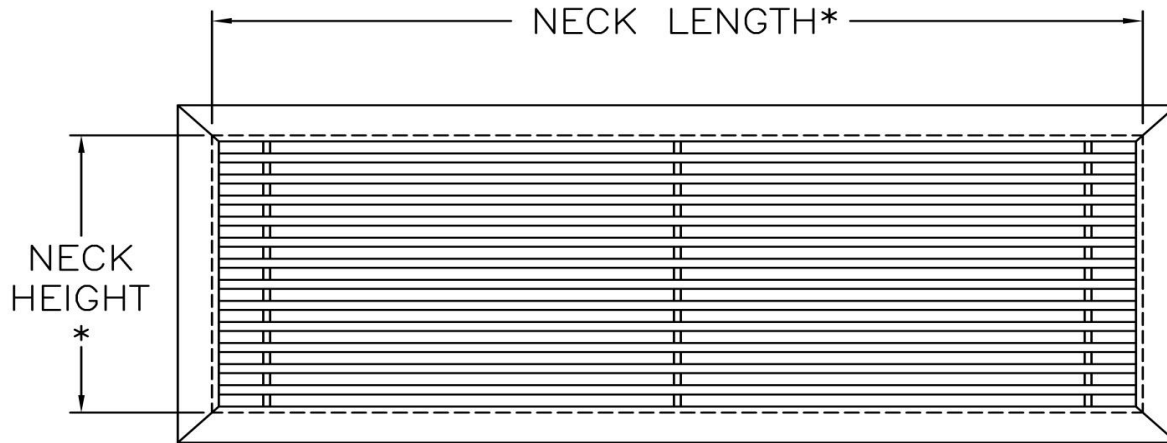

*GRILLE NECK SIZE IS 0.25" SMALLER THAN OPENING SIZE
 GRILLE OVERALL SIZE IS 1.25" BIGGER THAN GRILLE NECK SIZE

PLEASE FIELD VERIFY ALL DIMENSIONS

Advanced Architectural Grilleworks

149 Denton Avenue, New Hyde Park, NY 11040 Voice: 516-488-0628

Email: sales@aagrilles.com

JOB NUMBER:	SCALE: NOT TO SCALE
DWG NUMBER:	JOB NAME:
DRAWN BY:	MATERIAL:
DATE DRAWN:	FINISH:
LAST REV.:	