



# ADVANCED ARCHITECTURAL GRILLEWORKS

*Creating Artistry in Architectural Grilles & Metal*

## Installation Detail # 5

### WITH COUNTERSUNK MOUNTING HOLES

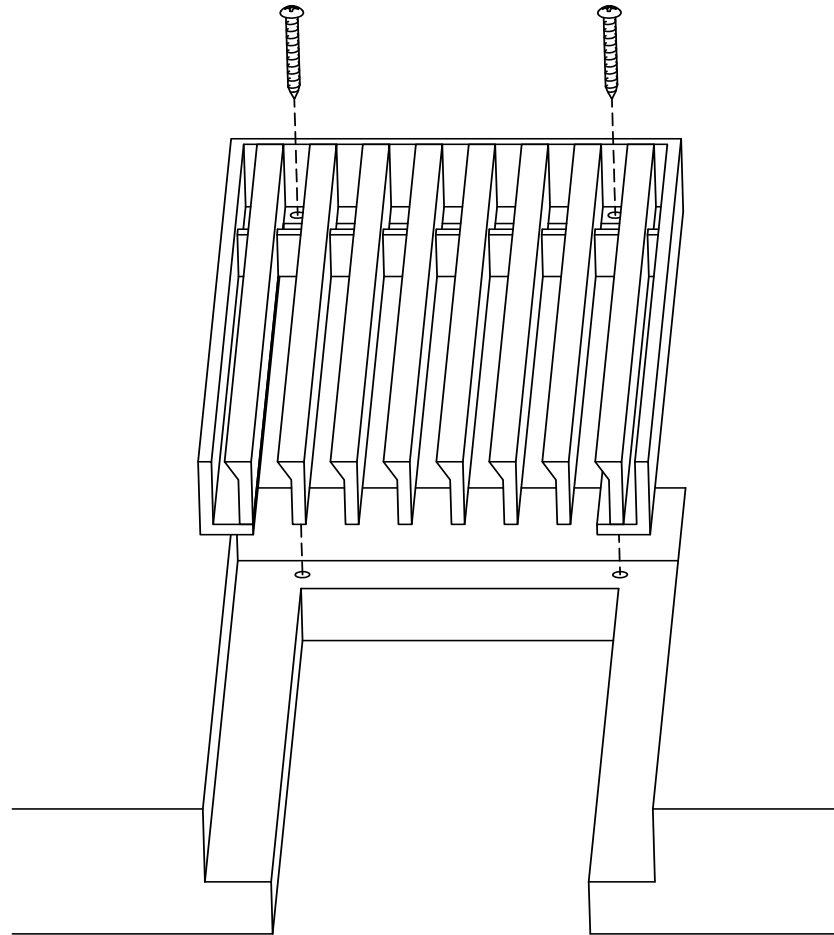

*Secures the grille and frame to:  
Wall openings, ceiling openings, floor vent access points,  
toe-kicks and under benches.  
AAG provides mounting fasteners with a matching finish.*

SECTION NAME: AAG220 A Frame

TITLE: Installation Detail # 5

DRAWN BY: AAG

DRAWING #: 05-1

DATE: 11-30-18

SCALE: Not To Scale

**Advanced Architectural Grilleworks**  
149 Denton Avenue, New Hyde Park, NY 11040  
Voice: 516-488-0628  
Email: sales@agrilles.com