



ADVANCED ARCHITECTURAL GRILLEWORKS

Creating Artistry in Architectural Grilles & Metal

Installation Detail # 12

WITH MOUNTING TABS

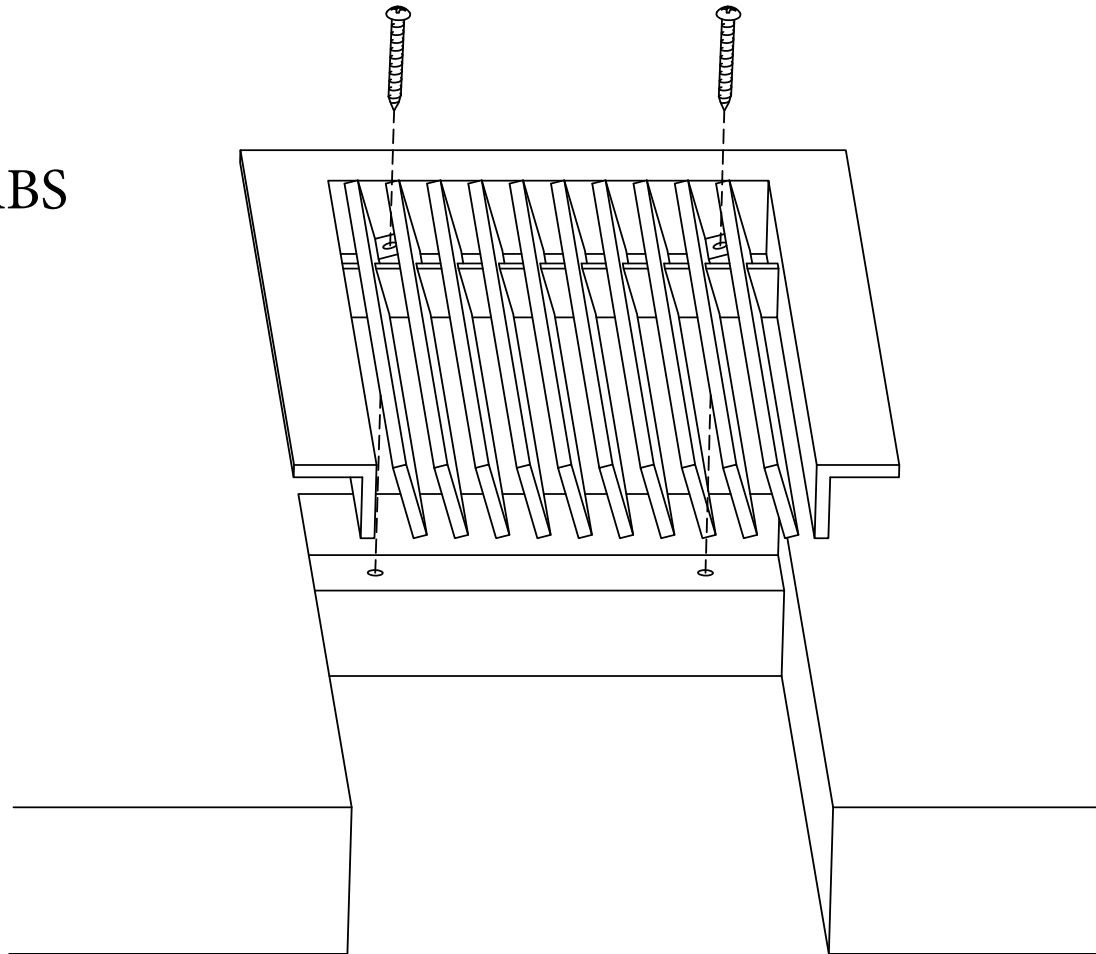

AAG Tip: We will fabricate the neck
1/8" smaller than your opening.

Used for multiple applications:

- Blocking
- Millwork
- Supports
- Angle/Duct flange

AAG provides mounting fasteners with matching finish

SECTION NAME: AAG400 B Frame

TITLE: Installation Detail # 12

DRAWN BY: AAG

DRAWING #: 12-1

DATE: 11-30-18

SCALE: Not To Scale

Advanced Architectural Grilleworks

149 Denton Avenue, New Hyde Park, NY 11040

Voice: 516-488-0628

Email: sales@agrilles.com