



ADVANCED ARCHITECTURAL GRILLEWORKS

Creating Artistry in Architectural Grilles & Metal

Installation Detail # 14

INVERTED WITH MOUNTING HOLES

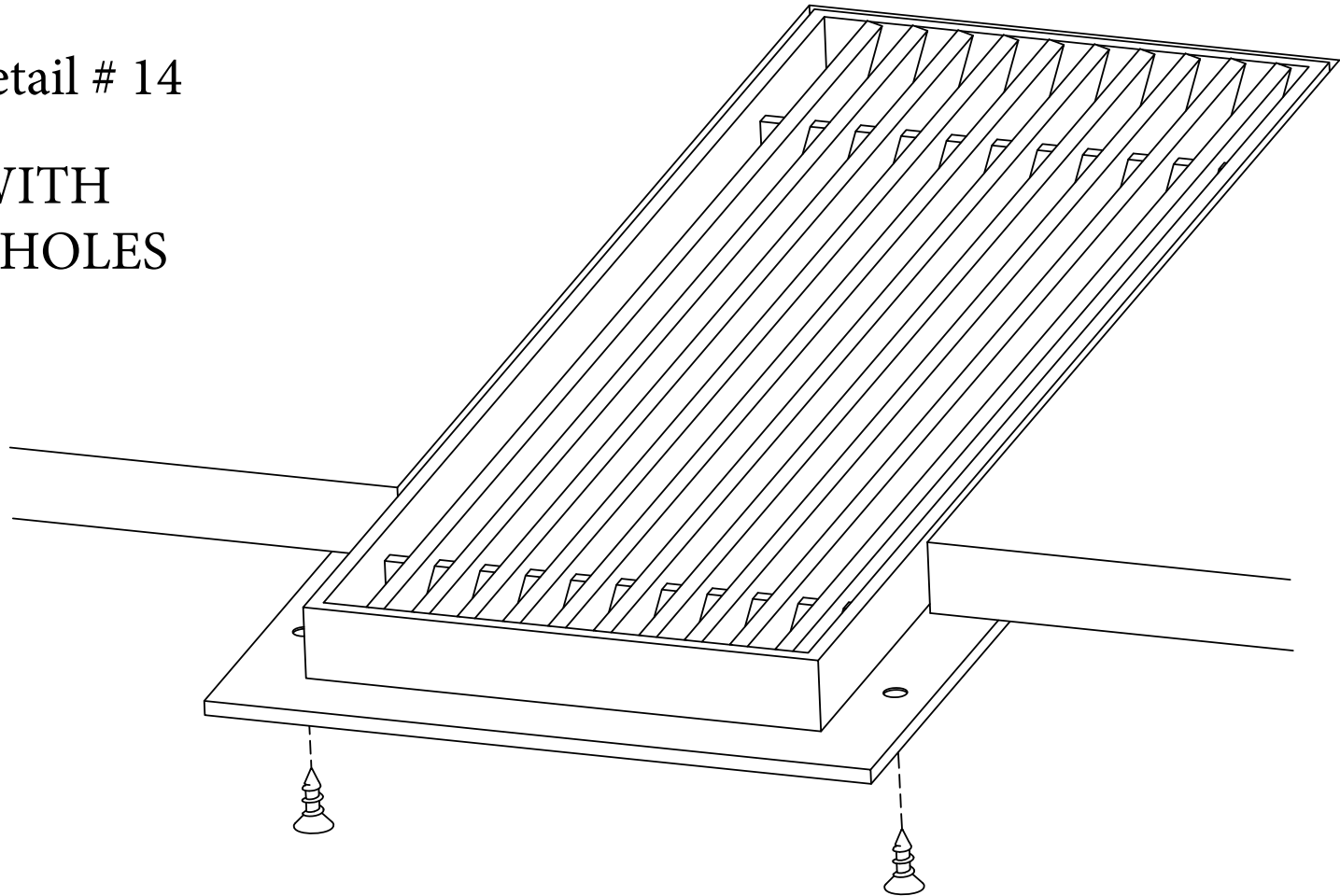

Used for multiple applications:

Used in millwork, as a thru-door grille or under mount for a counter.

AAG provides mounting fasteners with a matching finish.

SECTION NAME: AAG400 B Frame

TITLE: Installation Detail # 14

DRAWN BY: AAG

DRAWING #: 14-1

DATE: 11-30-18

SCALE: Not To Scale

Advanced Architectural Grilleworks

149 Denton Avenue, New Hyde Park, NY 11040

Voice: 516-488-0628

Email: sales@agrilles.com