



ADVANCED ARCHITECTURAL GRILLEWORKS

Creating Artistry in Architectural Grilles & Metal

Installation Detail # 22

PLASTER J-BEAD FRAME®

Patent #9,765,988

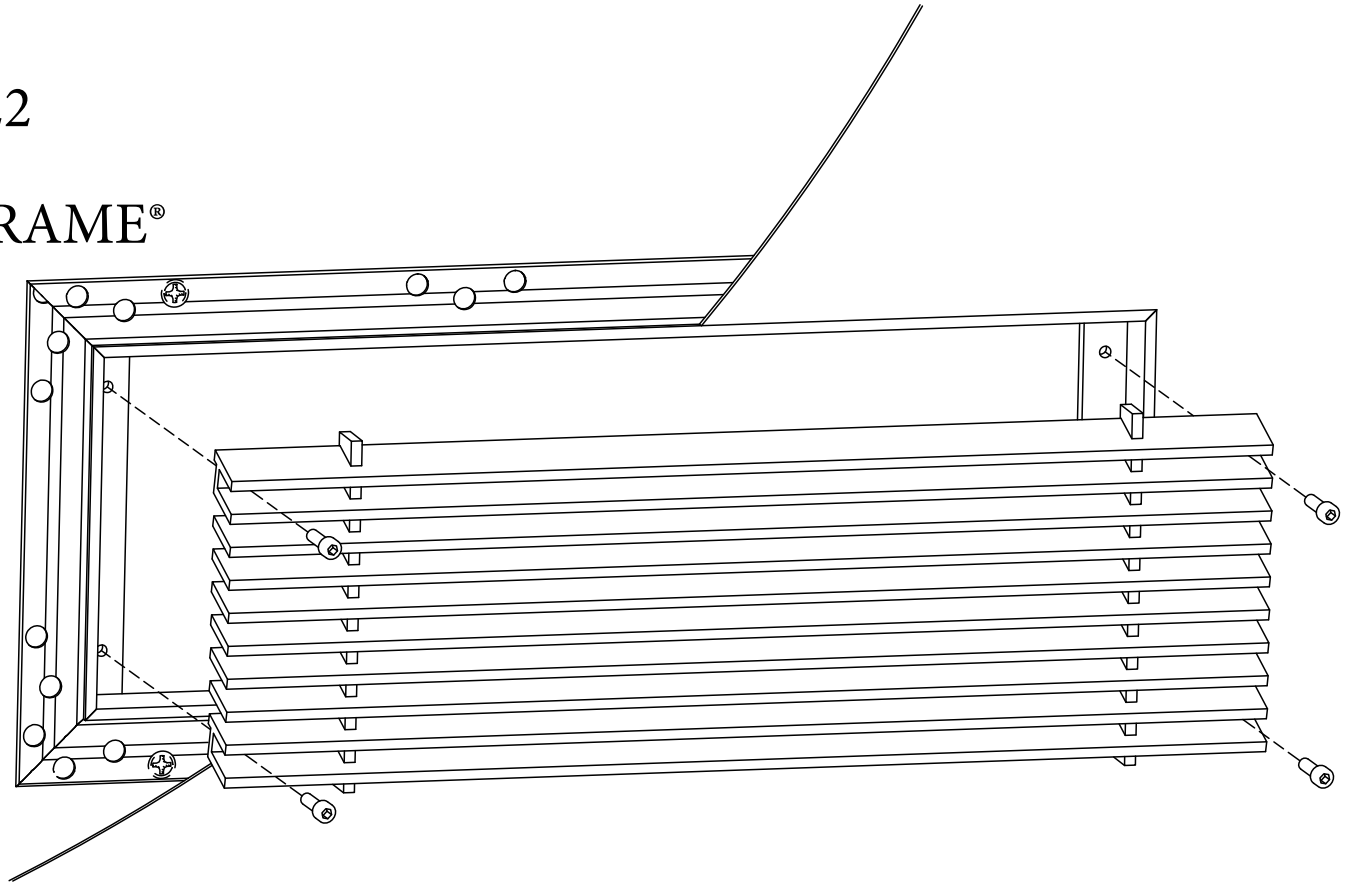

AAG Tip: Excellent choice when access is important.

Used for multiple applications:

- Ceiling
- Wall

AAG provides mounting fasteners with matching finish.

SECTION NAME: AAG400 J-Bead Frame

TITLE: Installation Detail # 22

DRAWN BY: AAG

DRAWING #: 22-1

DATE: 11-30-18

SCALE: Not To Scale

Advanced Architectural Grilleworks

149 Denton Avenue, New Hyde Park, NY 11040

Voice: 516-488-0628

Email: sales@aagrilles.com